

PLAN DE SITUATIE

scara 1:1000

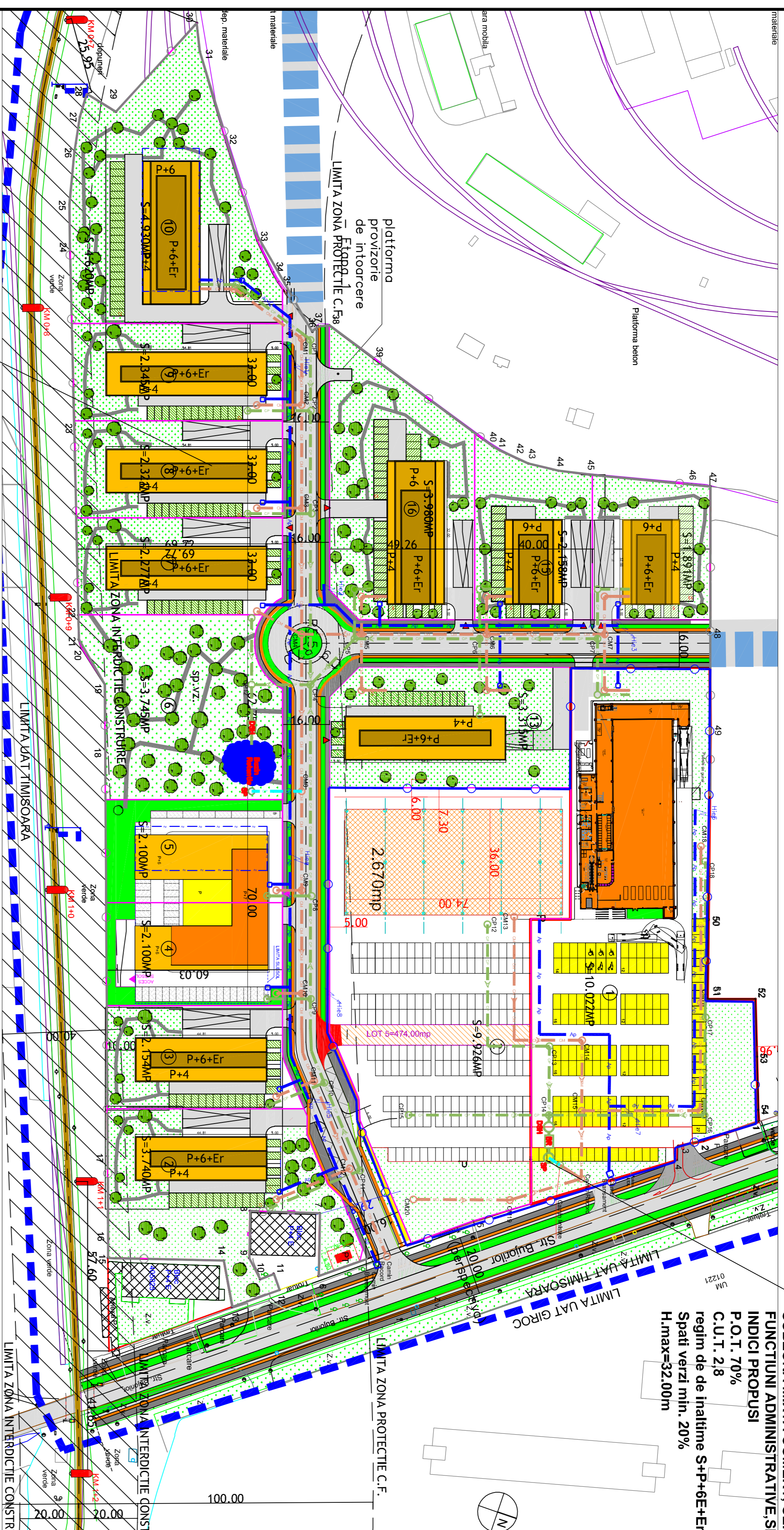

U.T.R.1
SUBZONA MIXTA COMERT. SERVICII
FUNCTIUNI ADMINISTRATIVE SI BIROURI
INDICI PROPUSI
P.O.T. 70%
C.U.T. 2.8
regim de de inaltime S+P+6E+Er
Spati verzi min. 20%
H-max=32.00m

U.T.R.2
SUBZONA MIXTA COMERT. SERVICII
SI LOCUIRE COLECTIVA
INDICI PROPUSI
P.O.T. 50%
C.U.T. 2.8
regim de de inaltime S+P+6E+Er
Spati verzi min. 20%
H-max=30.00m

PTT - 16 m
scara 1:100

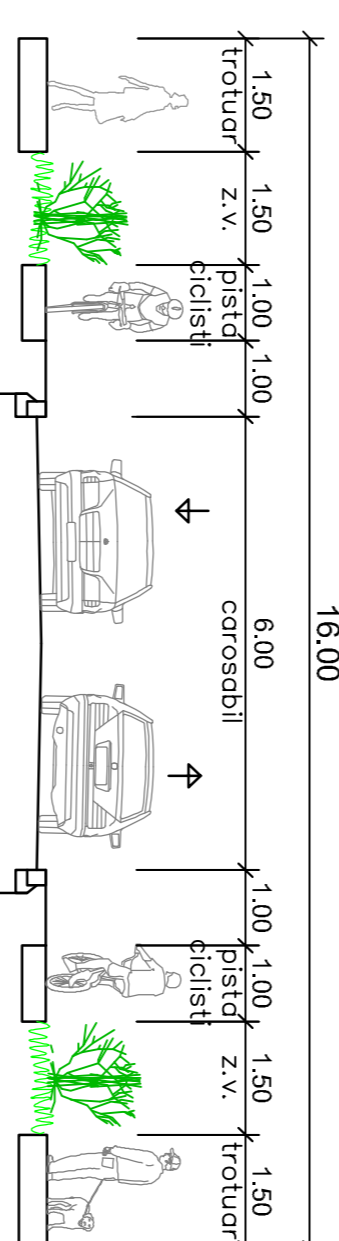

PLAN PARCELA tip A
locuinte si birou
scara 1:500

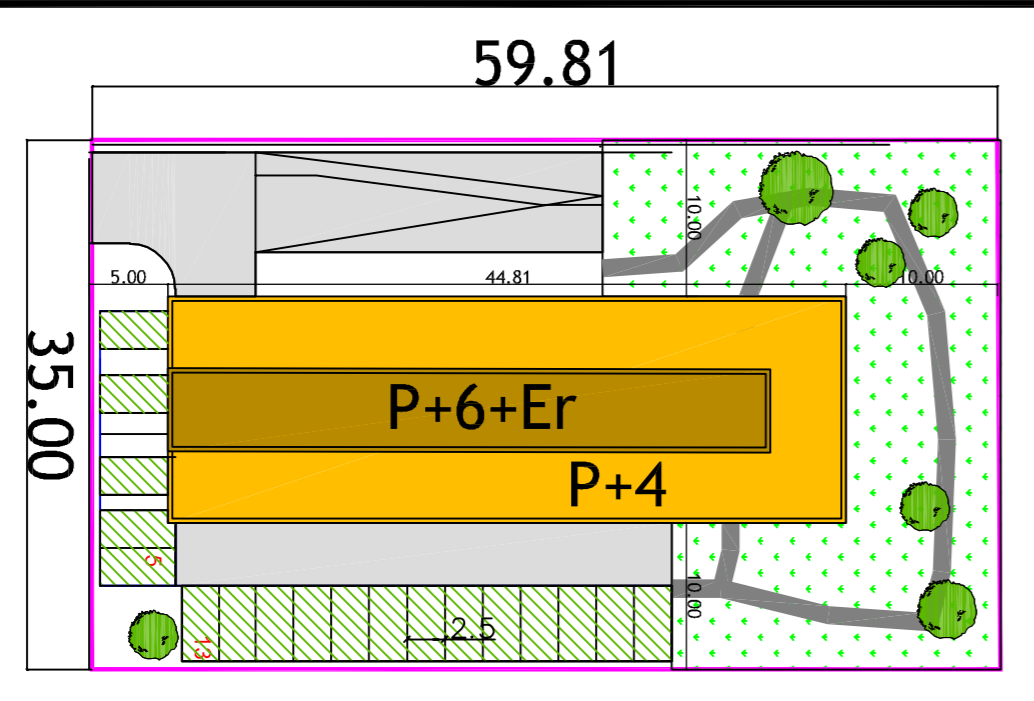

PLAN PARTER
Parcela tip A
scara 1:500

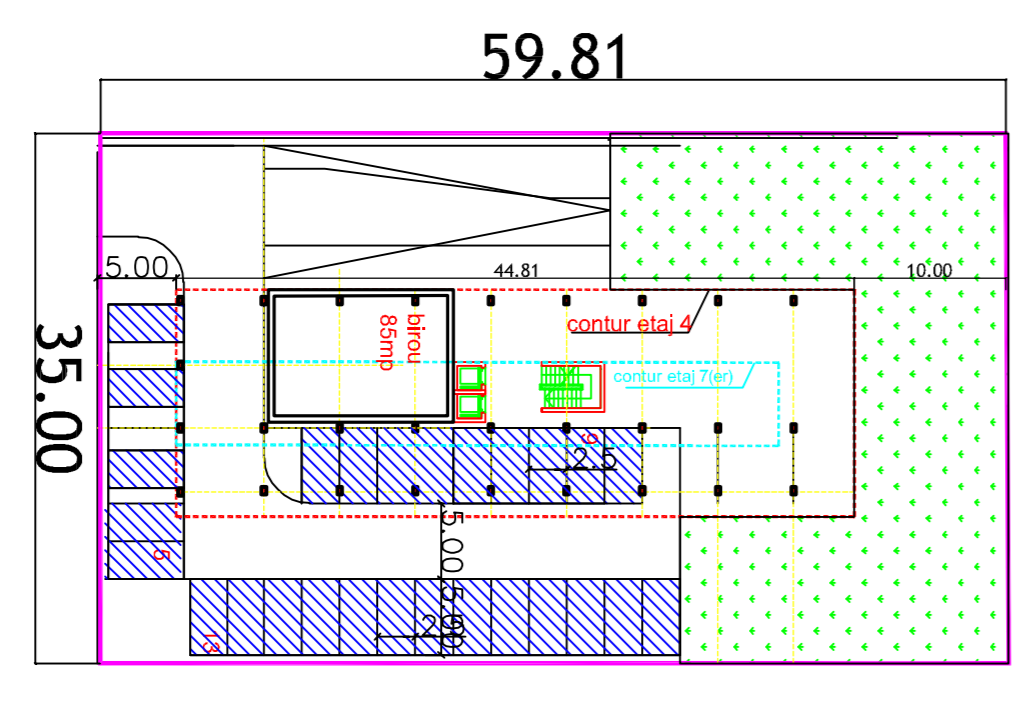

PLAN SUBSOL
Parcela tip A
scara 1:500

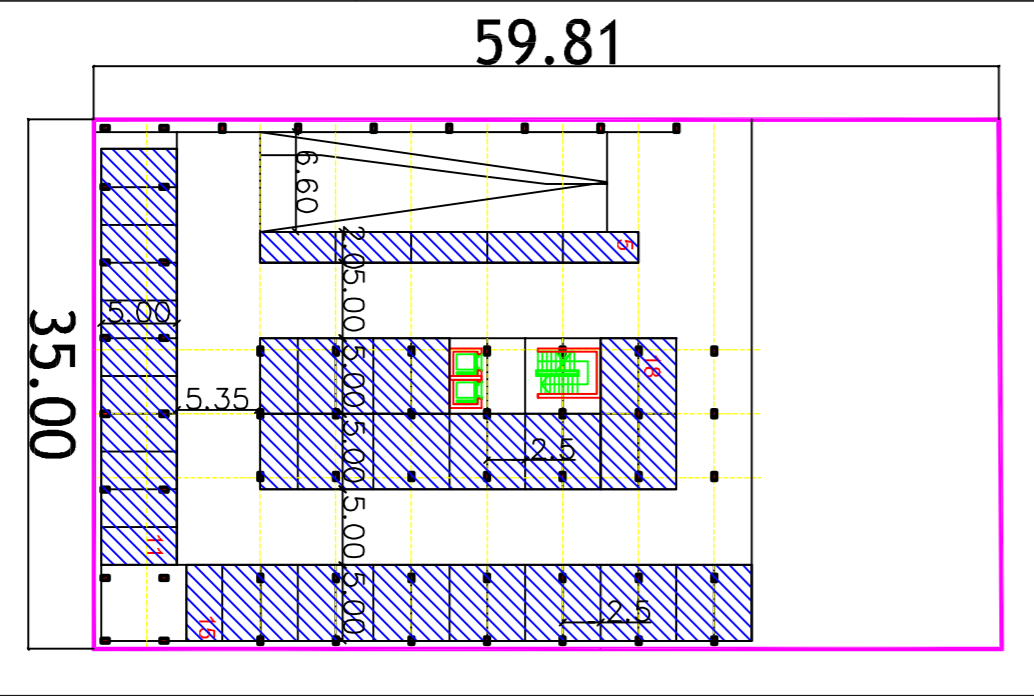

PLAN PARCELA tip B
locuinte
scara 1:500

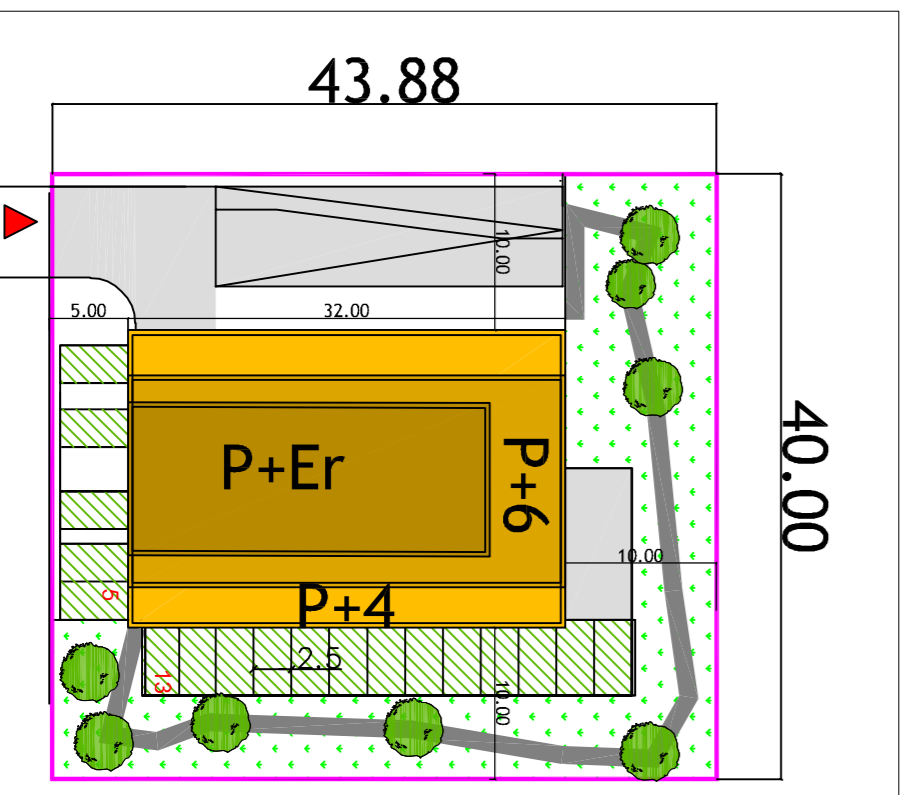

PLAN PARTER
Parcela tip B
scara 1:500

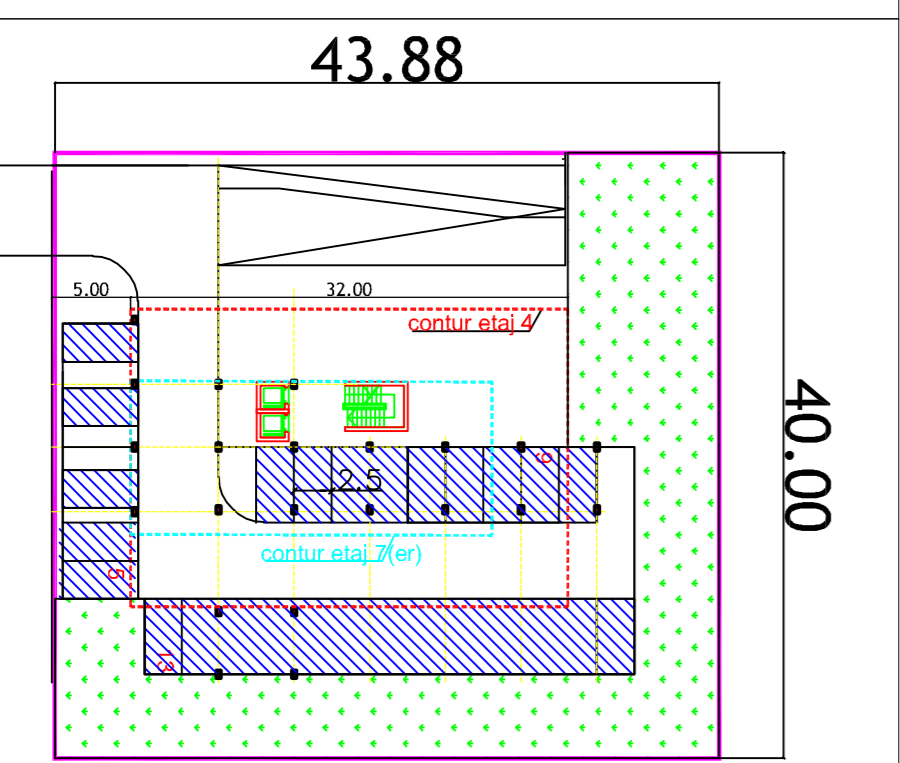

PLAN SUBSOL
Parcela tip B
scara 1:500

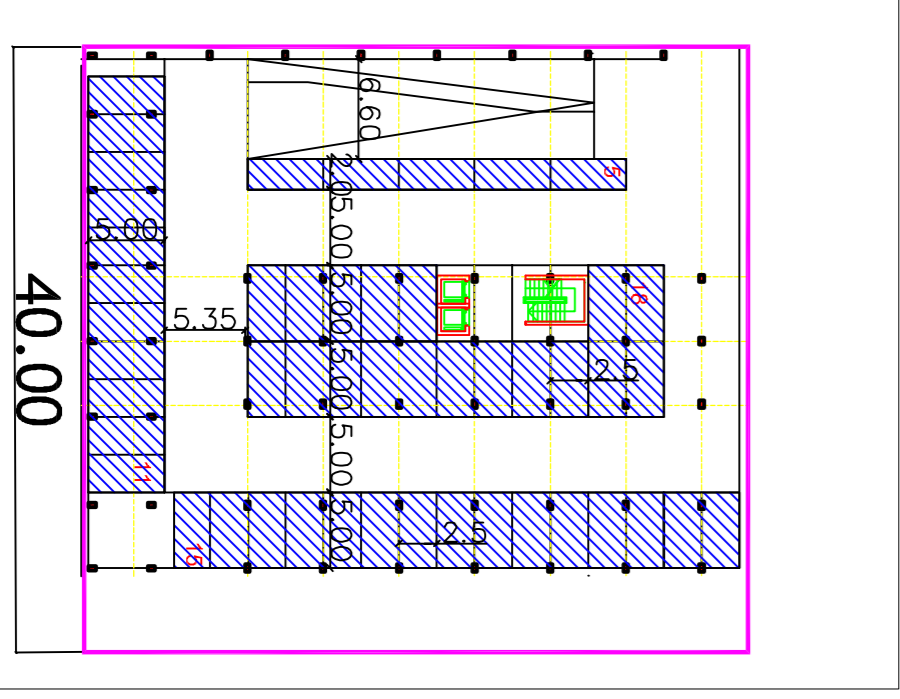

- Legenda:**
- Conducta de apa propusa
 - Conducta canalizare menajera propusa
 - Conducta canalizare pluviala propusa
 - Conducta refulare Stale pompare
 - DSH
 - CR
 - CA
 - Canal racord canalizare
 - Canal branșament apa
 - Hidroant de incendiu

PLAN GENERAL

scara 1:5000

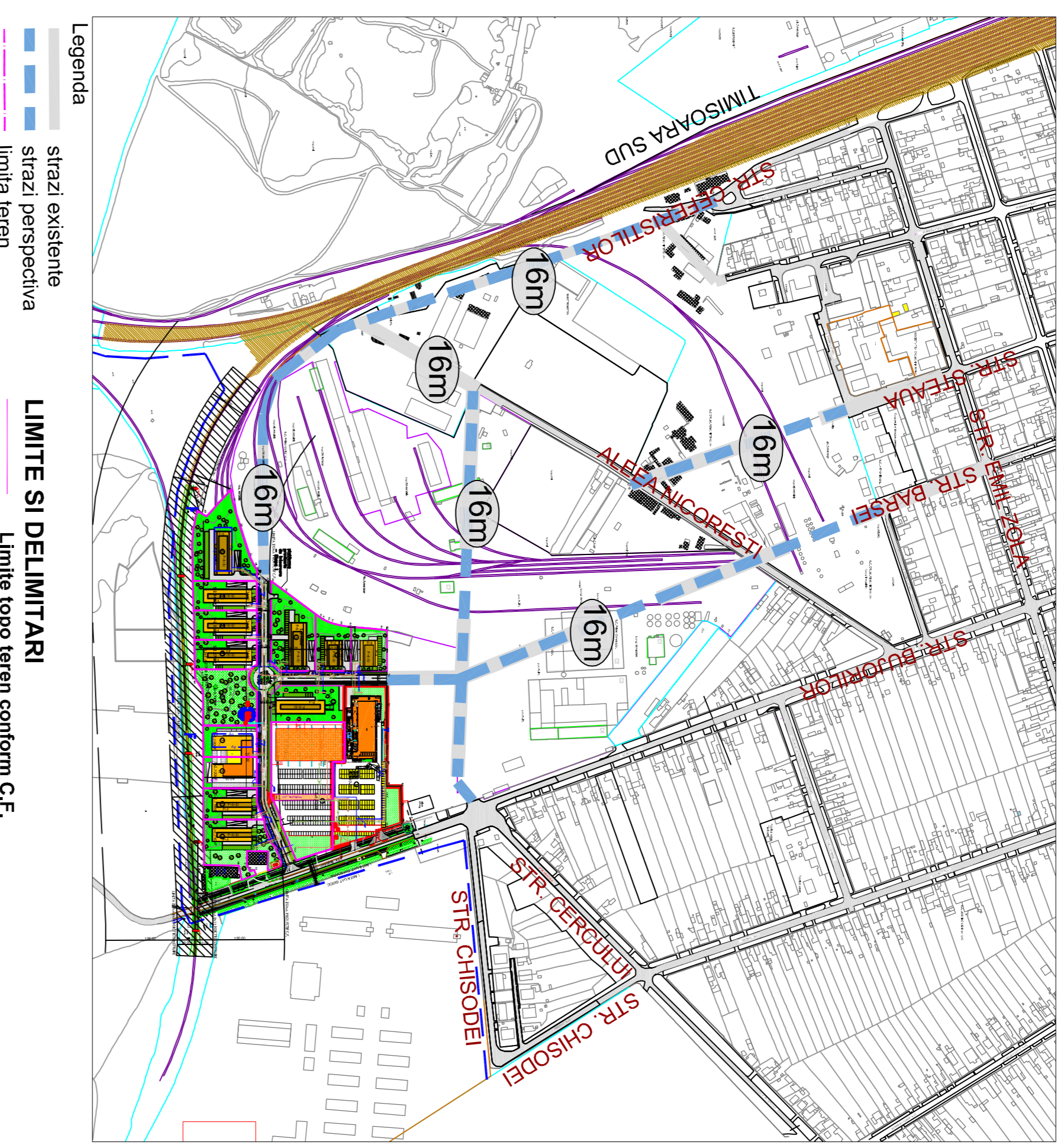

- Legenda**
- strazi existente
 - strazi perspectiva
 - limita teren
- LIMITE SI DELIMITARI**
- Limite topo teren conform C.F.
 - Limite teren ce face obiectul PUZ
 - Limita zona studiată
 - Limita UTR
 - Limita Intravilan
 - Limita zona implantare a cladirilor
 - Limita zona implantare a cladirilor in regim cuplat(comasare parcele)
- SIMBOLURI**
- Ciadirii existente
 - cl nr. 406302 Nr. Cf parcele
 - S=64.488mp existente

SECTIUNI TRANSVERSALE
Parcela tip A
scara 1:500

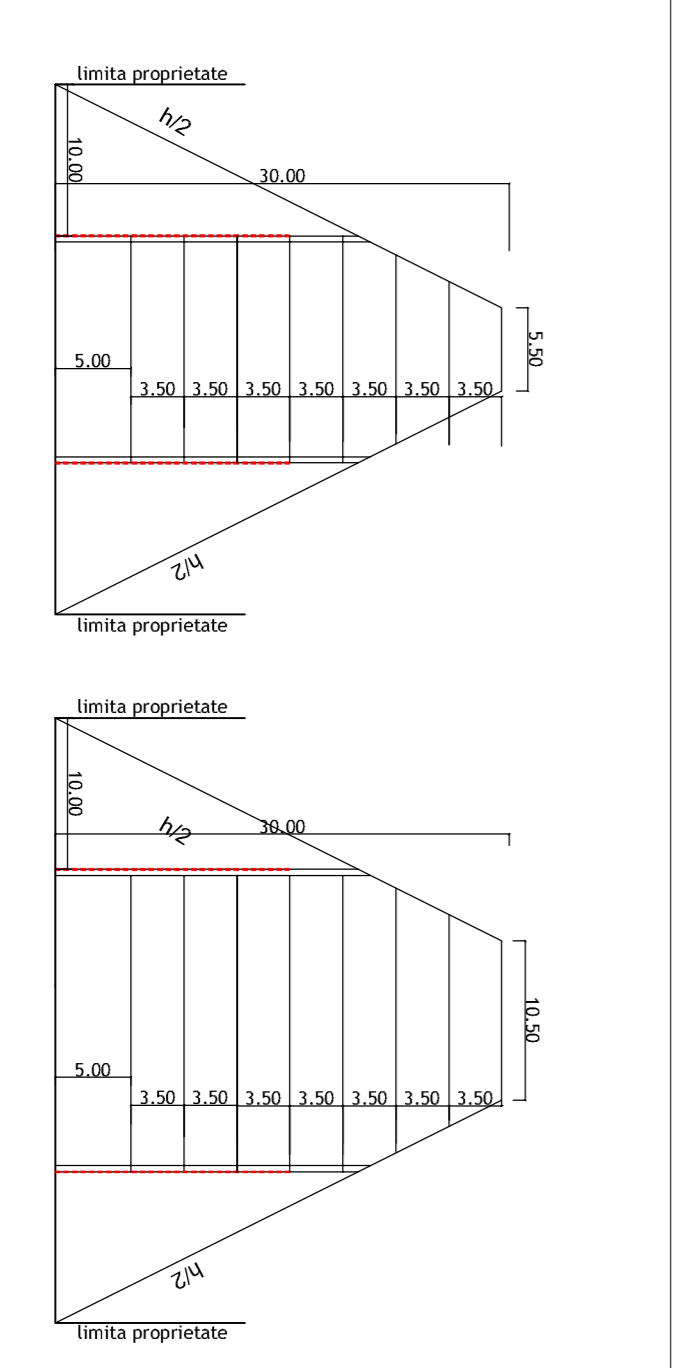

Sesiunea nr.1		An: Anca Angheliescu	
PROIECTANT GENERAL:			
S.C. TB DEZVOLTAIRE SERV S.R.L.		P.U.Z. 7 Modificarea PUZ aprobat cu HCL	
CUI38828299 J3537512016 tel: +40756806293		Timpsonara nr. 3917018 Esplanada UTR1	
PROIECTANT SPECIALITATE			
S.C. 903 STUDIOARH S.R.L.		administrative si birouri	
CUI34925493 J35362519 TEL: +40742026555		Beneficiar: SECURITATEA INSTRIKAL SA	
Sf. proiect: An.Ludmila Stancu		Scara: 1:1.000	
Proiectat: Ing. Bogdan Morodoc		Data: august 2019	
Desenat: Ing. Bogdan Morodoc		Demarure planșe:	
Verificat: Ing. Bogdan Morodoc		Plan de situare cadastre	
		P.U.Z.	
		EDAU1	