

PLAN RELEVU APARTAMENT NR. 2

sc.: 1:100

BEZNOSZK Semnat digital de
A BEZNOSZKA
LOREDANA LOREDANA
 Data: 2020.04.02
 13:03:22 +03'00'

Nr. cadastral	Suprafata (mp)	Adresa imobilului (UI)	
448798	2720	Str. Vacarescu, nr. 18, Municipiul Timisoara	
Cartea Funciara colectiva nr.	448798-C1	UAT	Timisoara
Cod unitate individuala (U)		C.F. individuala	

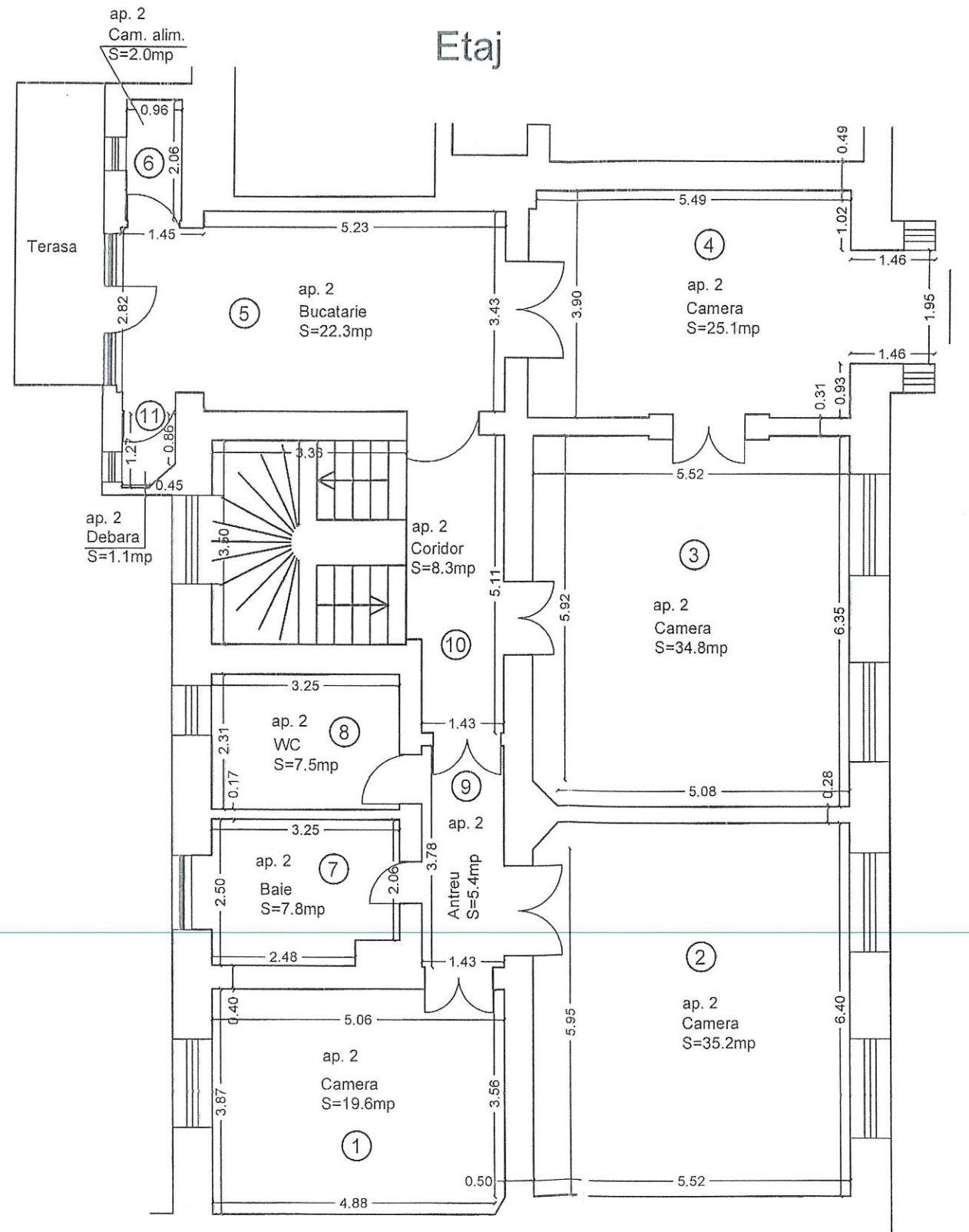

Demisol

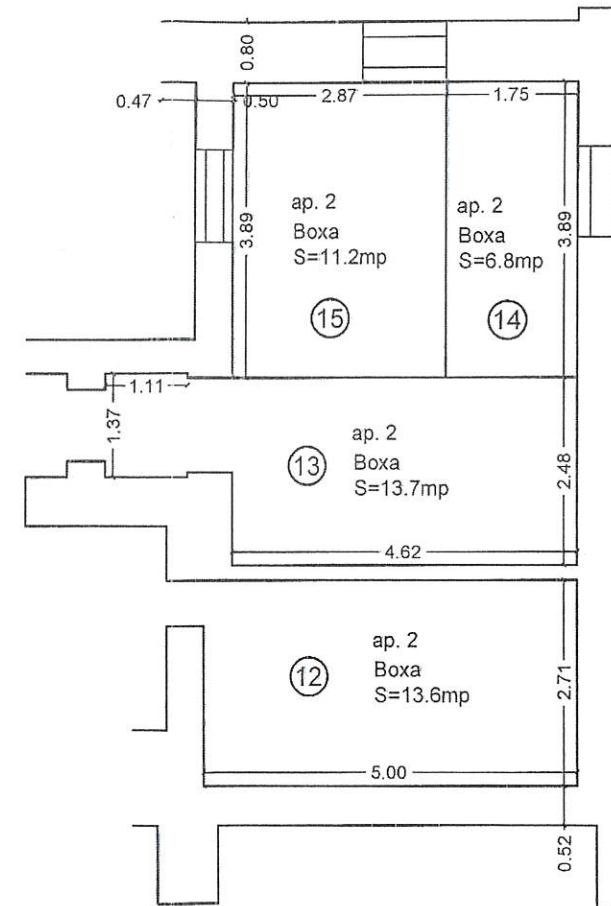

Parter

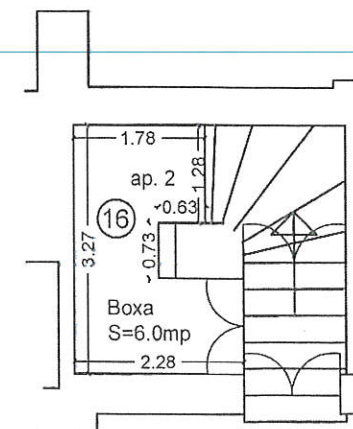

Nr. incapere	Denumire incapere	Supraf. utila
ap. 2 - etaj si demisol		
1	camera	19.6
2	camera	35.2
3	camera	34.8
4	camera	25.1
5	bucatarie	22.3
6	camara alimente	2.0
7	baie	7.8
8	WC	7.5
9	antreu	5.4
10	coridor	8.3
11	debara	1.1
12	boxa	13.6
13	boxa	13.7
14	boxa	6.8
15	boxa	11.2
16	boxa	6.0

Suprafata utila = 220.4 mp

Suprafata totala = 220.4 mp

Executant,	Data
S.C. BLACK LIGHT S.R.L. ing. Loredana Beznoszka	2020
Receptionat,	Data

Srdjan Rankov Digitally signed
 by Srdjan Rankov
 Date: 2020.04.16
 14:43:53 +03'00'

BEZNOSZK Semnat digital
 A de BEZNOSZKA
 LOREDANA LOREDANA
 Data: 2020.04.02
 13:04:32 +03'00'

PLAN RELEVU APARTAMENT NR. 4

sc.: 1:100

Nr. cadastral	Suprafata (mp)	Adresa imobilului (UI)	
448798	2720	Str. Vacarescu, nr. 18, Municipiul Timisoara	
Cartea Funciara colectiva nr.	448798-C1	UAT	Timisoara
Cod unitate individuala (U)		C.F. individuala	

Parter

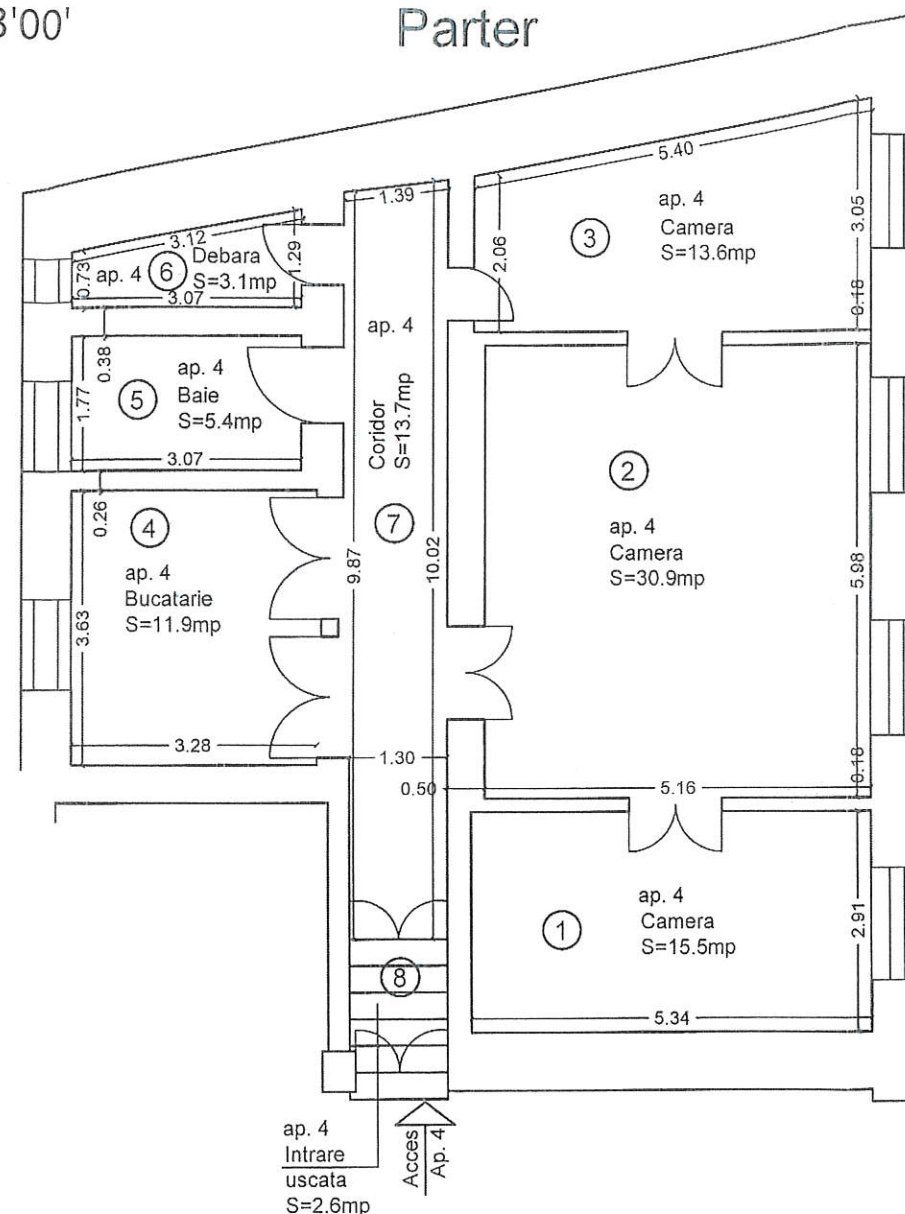

Demisol

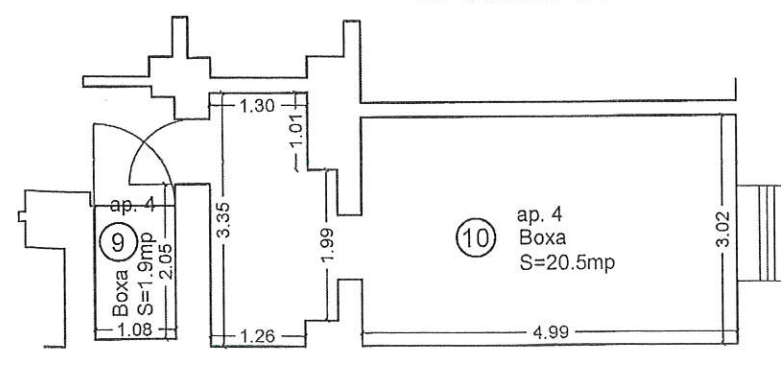

Nr. incapere	Denumire incapere	Supraf. utila
ap. 4 - parter si demisol		
1	camera	15.5
2	camera	30.9
3	camera	13.6
4	bucatarie	11.9
5	baie	5.4
6	debara	3.1
7	coridor	13.7
8	intrare uscata	2.6
9	boxa	1.9
10	boxa	20.5

Suprafata utila = 119.1 mp

Suprafata totala = 119.1 mp

Executant,	Data
S.C. BLACK LIGHT S.R.L. ing. Loredana Beznoszka	2020

Receptionat,	Data
Srdjan Rankov	2020

Srdjan Rankov Digitally signed
 by Srdjan Rankov
 Date: 2020.04.16
 14:47:20 +03'00'

**BEZNOSZKA
LOREDANA**

Semnat digital de
BEZNOSZKA
LOREDANA
Data: 2020.04.15
14:26:33 +03'00'

PLAN RELEVU APARTAMENT NR. 2-3

sc.: 1:100

Nr. cadastral	Suprafata (mp)	Adresa imobilului (UI)	
448798	2720	Str. Vacarescu, nr. 18, Municipiul Timisoara	
Cartea Funciara colectiva nr.	448798-C1	UAT	Timisoara
Cod unitate individuala (U)		C.F. individuala	

Etaj

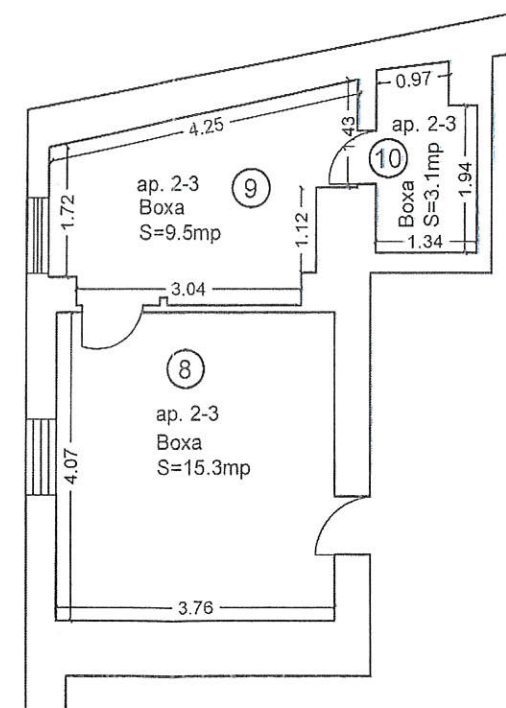
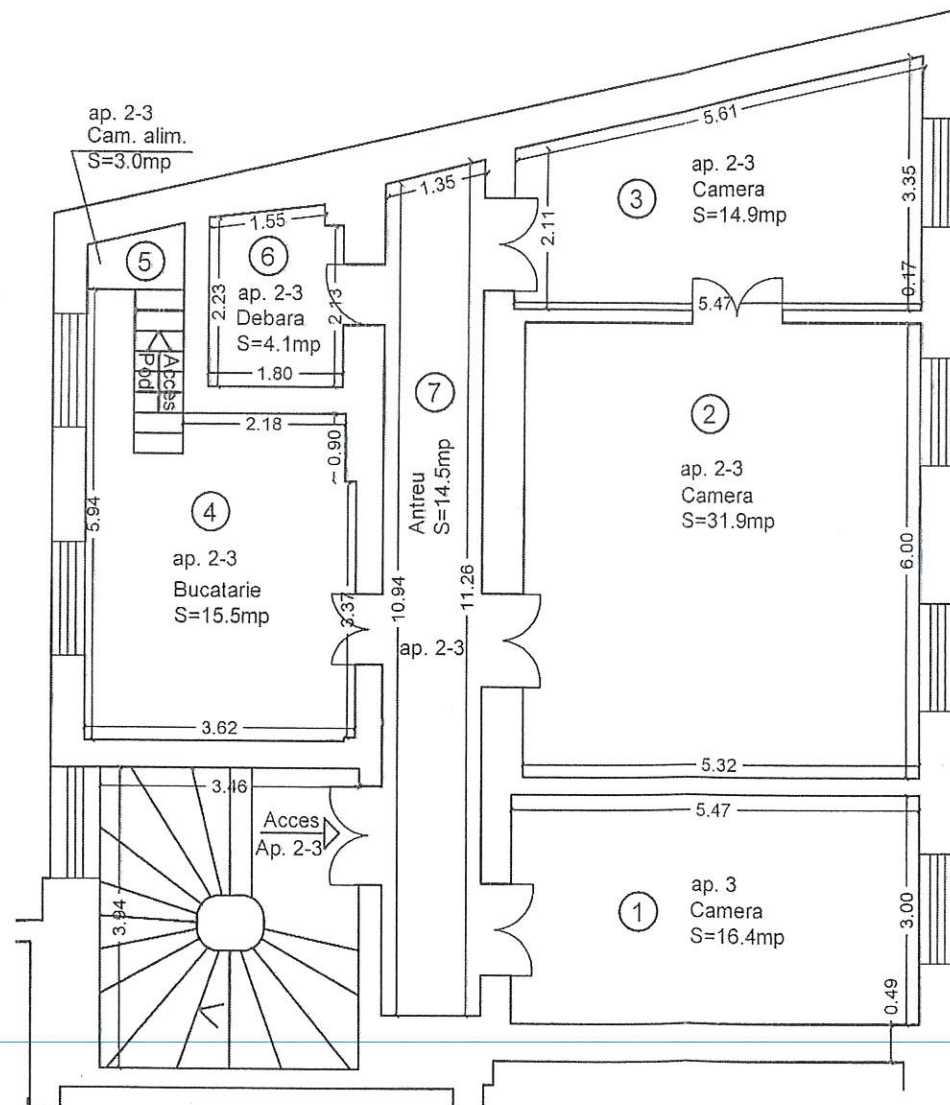

Nr. incapere	Denumire incapere	Supraf. utila
ap. 2-3 - etaj		
1	camera	16.4
2	camera	31.9
3	camera	14.9
4	bucatarie	15.5
5	camara alimente	3.0
6	debara	4.1
7	antreu	14.5
Suprafata utila = 100.3 mp		
8	boxa	15.3
9	boxa	9.5
10	boxa	3.1
Suprafata totala = 128.2 mp		
Executant,		Data
S.C. BLACK LIGHT S.R.L. ing. Loredana Beznoszka		2020
Receptionat,		Data

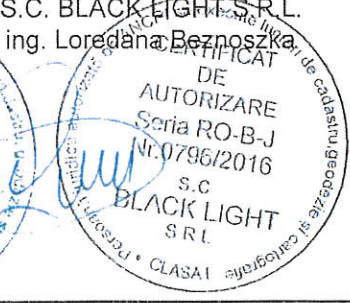

**Srdjan
Rankov**

Digitally signed
by Srdjan
Rankov
Date:
2020.04.16
14:53:08 +03'00'

BEZNOSZKA LOREDANA

Semnat digital de
BEZNOSZKA LOREDANA

Data: 2020.04.02

13:09:02 +03'00'

Parter

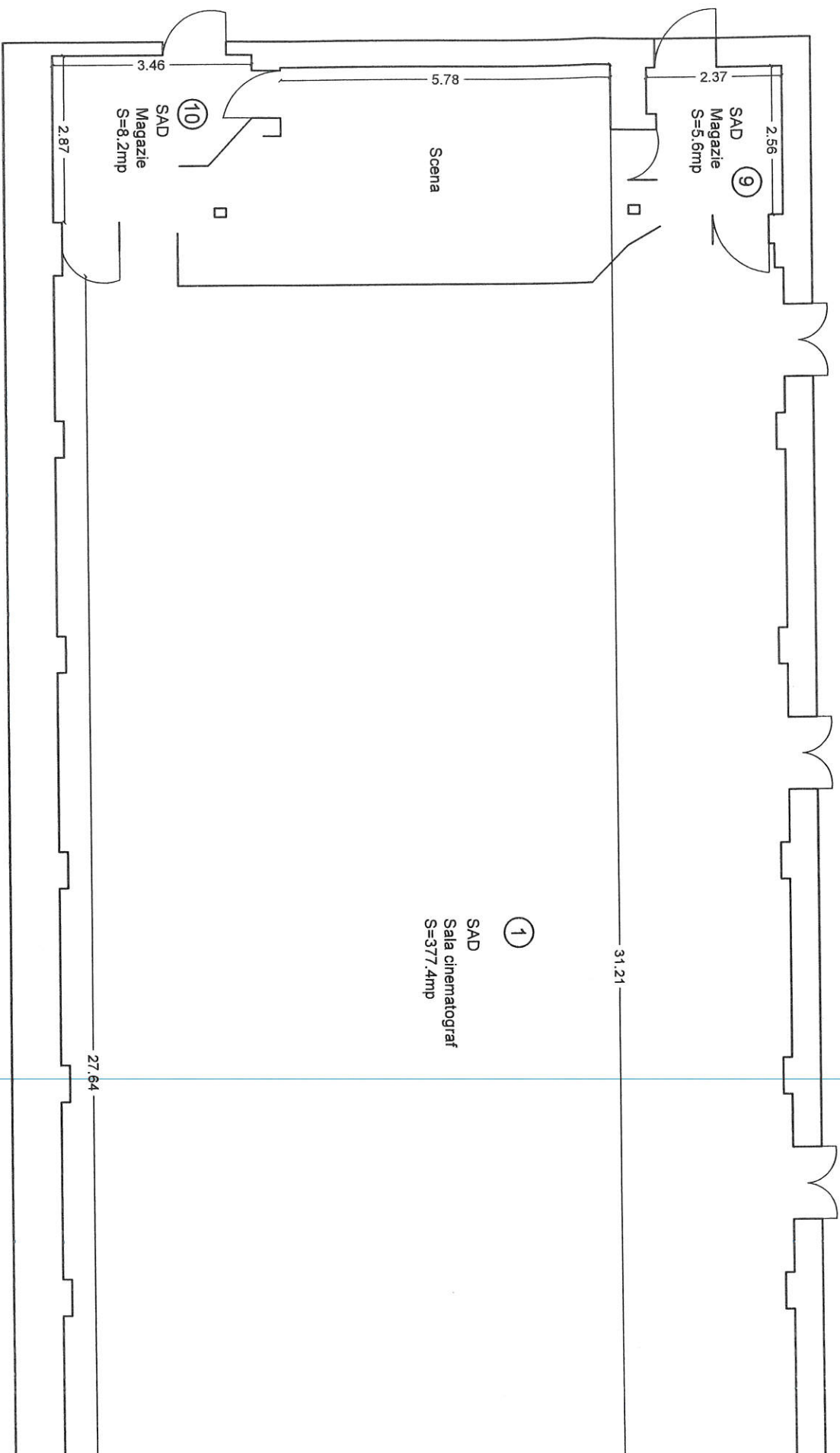

Etaj

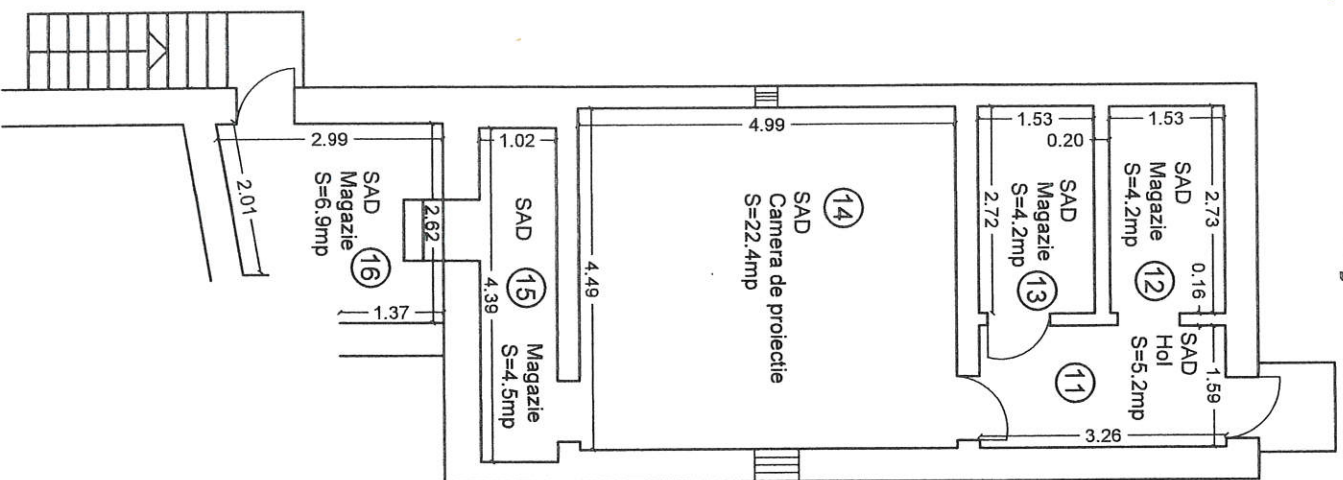

Demisol

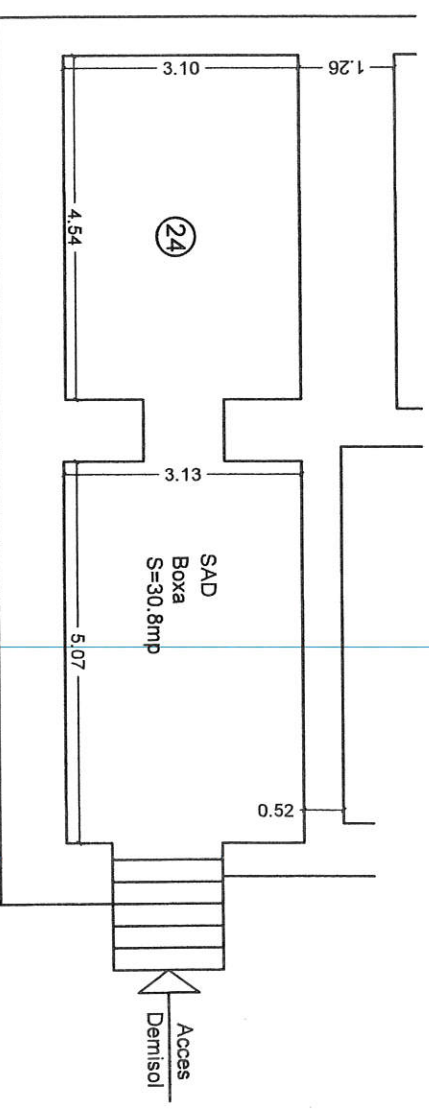

PLAN RELEVUEU SAD

Nr. cadastral	Suprafata (mp)	Adresa imobilului (UI)	
448798	2720	Str. Vacarescu, nr. 18, Municipiul Timisoara	
Cartea Funciara colectiva nr.	448798-C1	UAT	Timisoara
Cod unitate individuala (U)		C.F. individuala	

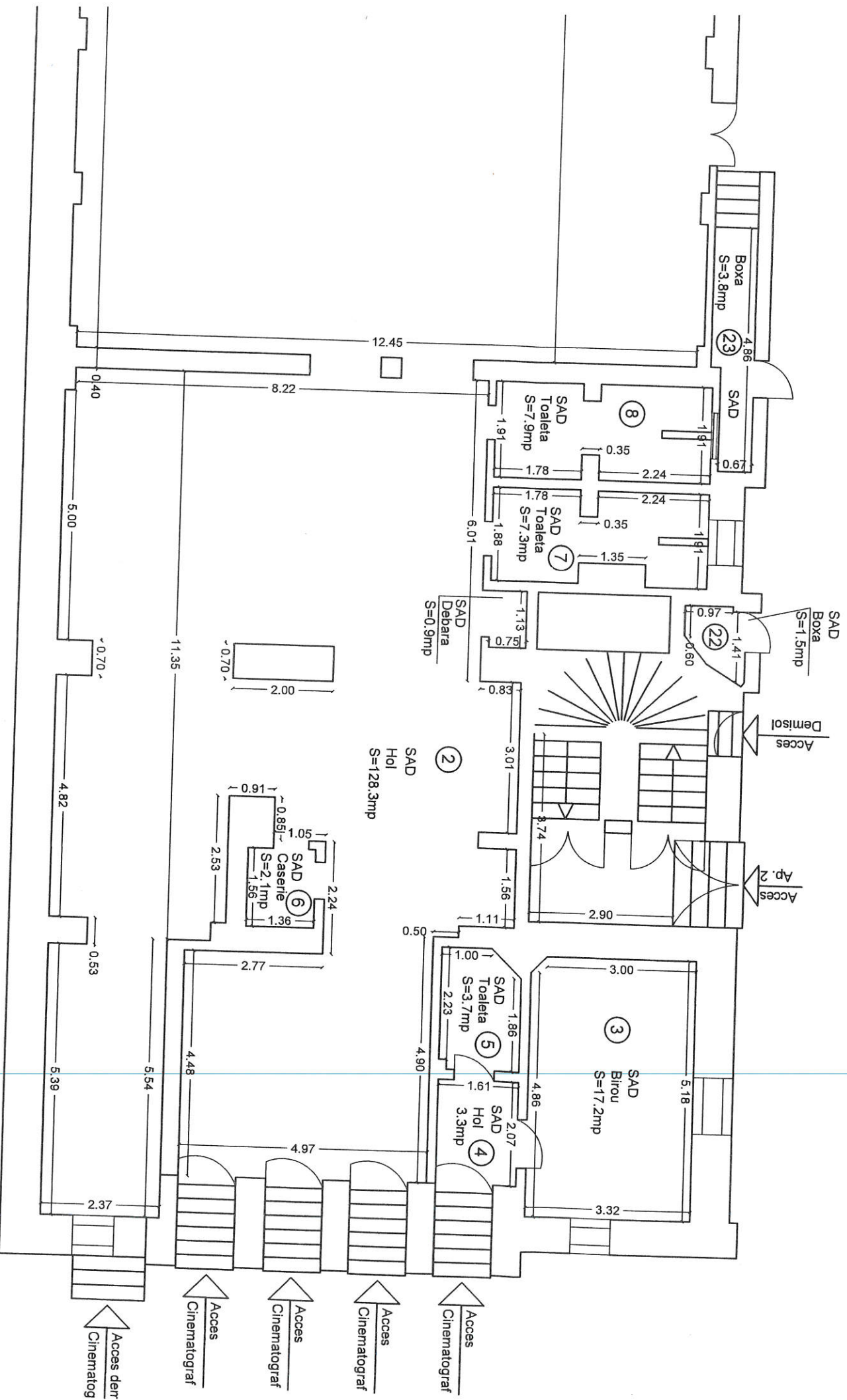

Etaj

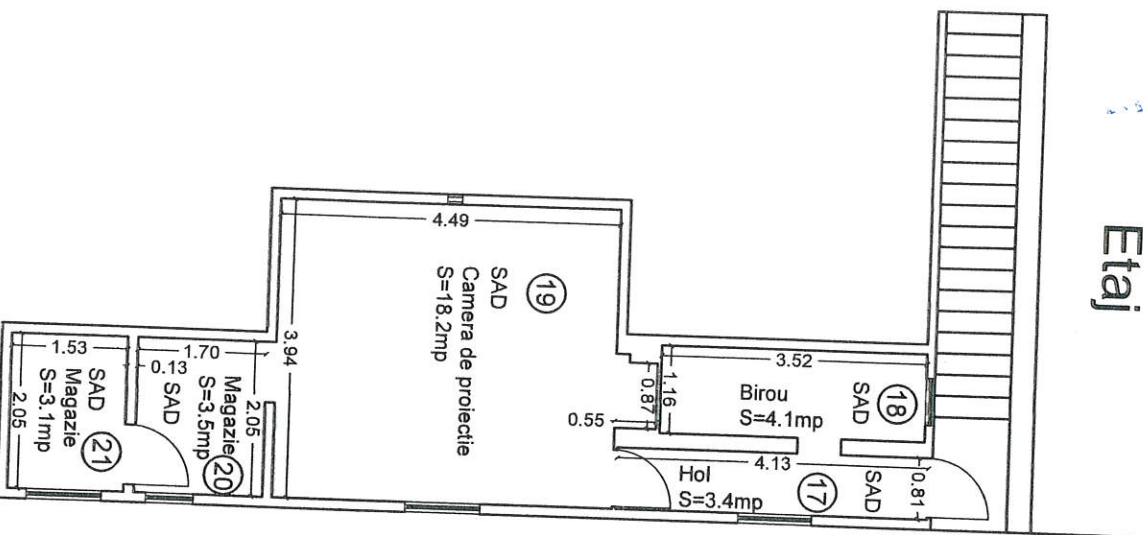

Nr. incaperere	Denumire incaperere	Supraf. utila
SAD - parter, etaj si demisol		
1	sala cinematograf	377.4
2	hol	128.3
3	birou	17.2
4	hol	3.3
5	toaleta	3.7
6	caserie	2.1
7	toaleta	7.3
8	toaleta	7.9
9	magazie	5.6
10	magazie	8.2
11	hol	5.2
12	magazie	4.2
13	magazie	4.2
14	camera de proiectie	22.4
15	magazie	4.5
16	magazie	6.9
17	hol	3.4
18	birou	4.1
19	camera de proiectie	18.2
20	magazie	3.5
21	magazie	3.1
22	boxa	1.5
23	boxa	3.8
24	boxa	30.8
Suprafata utila = 676.8 mp		
Suprafata totala = 676.8 mp		

Executant,	Data
S.C. BLACK LIGHT S.R.L. Ing. Loredana Beznoszka	2020
Receptionat,	Data



Digitally signed by Srdjan Ranko
 Date: 2020.04.16 14:49:26 +03'00'

BEZNOSZKA LOREDANA

Semnat digital de
BEZNOSZKA LOREDANA
Data: 2020.04.02 13:07:54
+03'00'

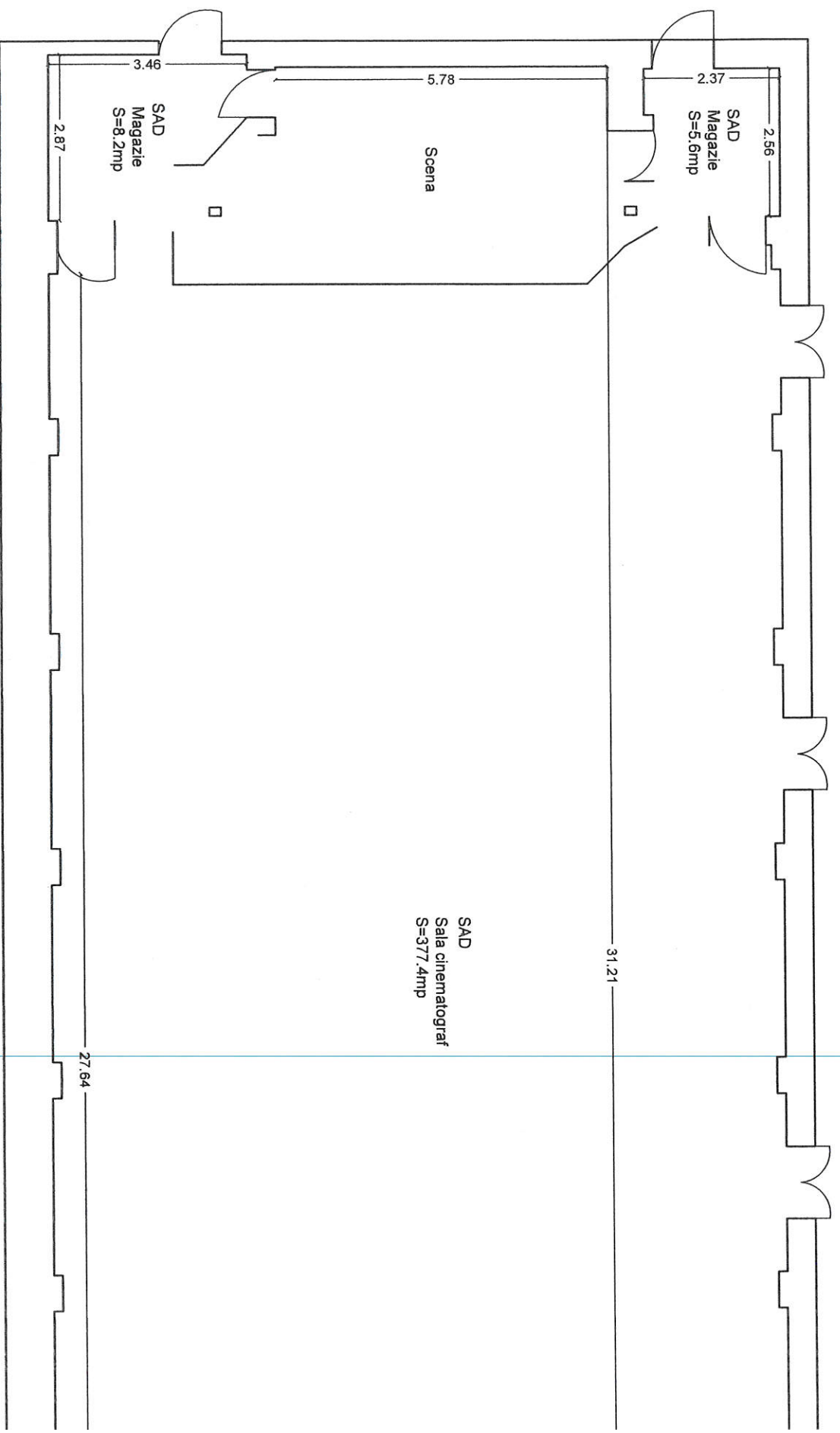
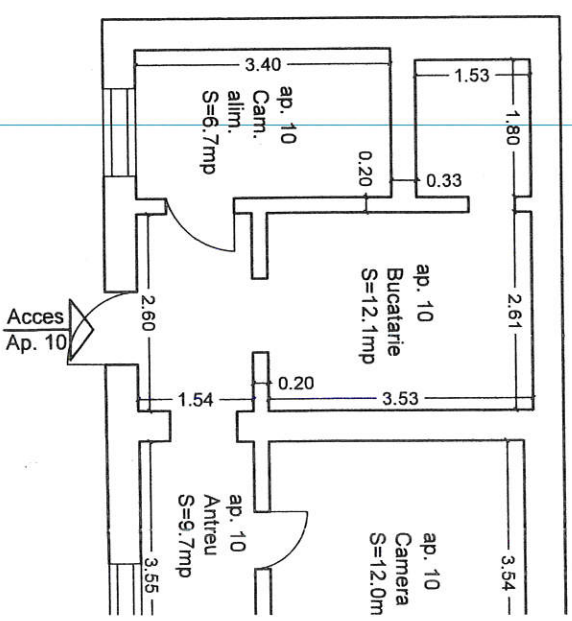

Srdjan

Digitally signed
by Srdjan Rankov

Rankov

Date: 2020.04.16
14:51:08 +03'00'

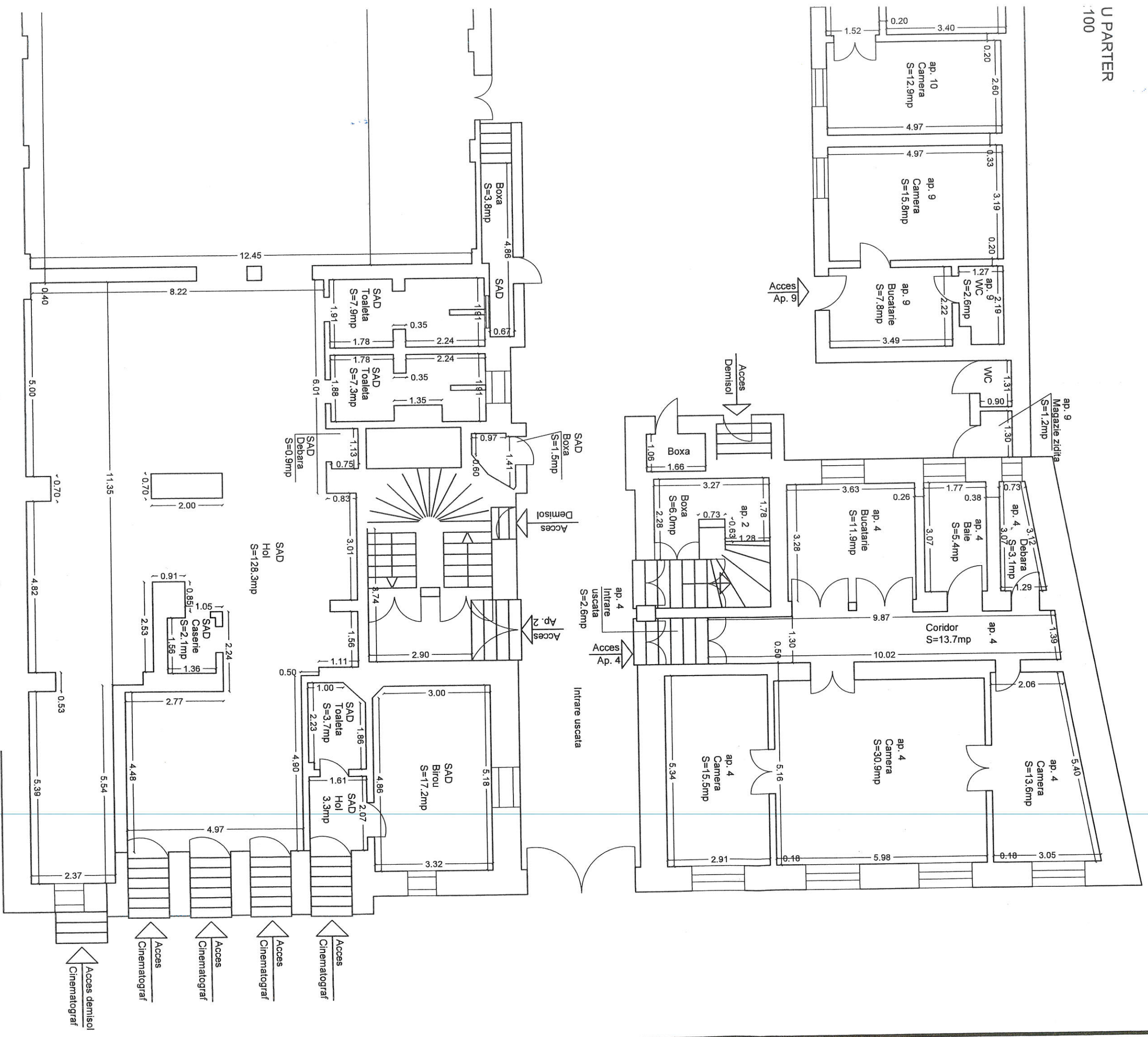

Timisoara, str. Virtutii nr. 1
Tel.: 0356 - 808 870
Fax: 0356 - 808 871
e-mail: office@blacklight.ro

Denumire proiect: Documentatie pentru apartamentare casa
cu 1 etaj, situata in Municipiul Timisoara, str. Iancu
Văcărescu, nr. 18
Beneficiar: Primaria Municipiului Timisoara

Nr. proiect: 2777A/2018

Şef proiect	ing. Loredana BEZNOSZKA	Scara	Planşe:	Faza: AP
Intocmit	ing. Loredana BEZNOSZKA	1:100	Plan releveu parter	
Desenat	ing. Loredana BEZNOSZKA	Data		Planşa Nr. 3

BEZNOSZKA

LOREDANA

Semnat digital de BEZNOSZKA
LOREDANA

Data: 2020.04.02 13:07:18
+03'00'

PLAN REL
scarz

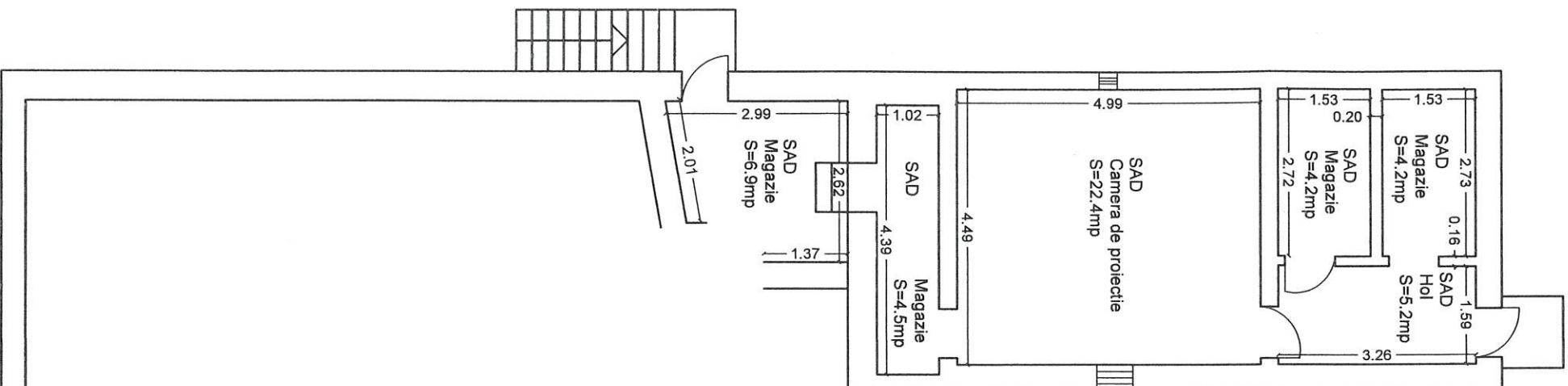

Srdjan

Digitally signed
by Srdjan Rankov

Rankov

Date: 2020.04.16
14:46:34 +03'00'

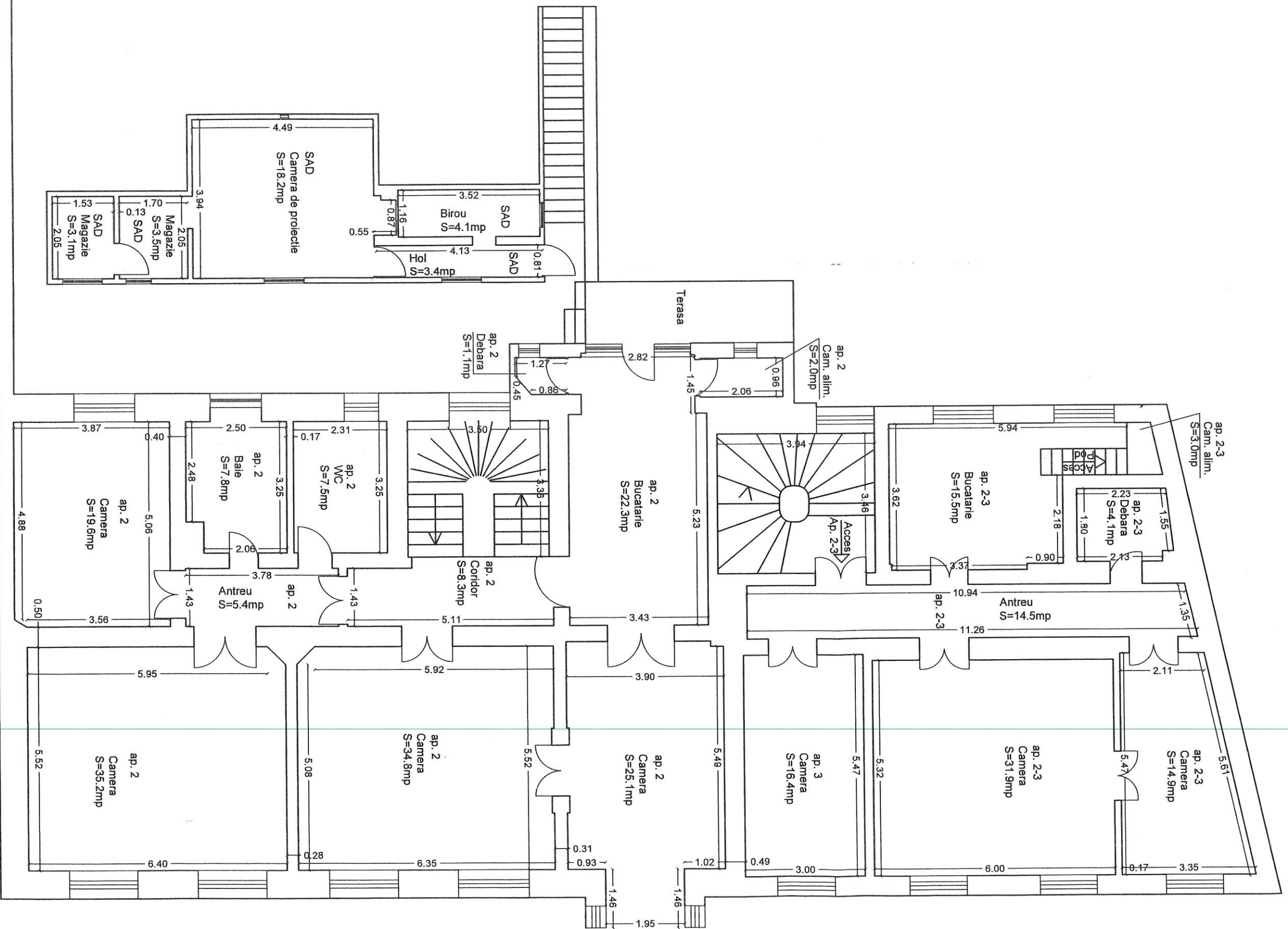

Timisoara, str. Virtutii nr. 1
 Tel.: 0356 - 808 870
 Fax: 0356 - 808 871
 e-mail: office@blacklight.ro

Nr. proiect
2777A/201

Șef proiect	ing. Loredana BEZNOȘKA	Scara	1:100	Planșe:	Plan relevu etaj	Faza:	AP
Intocmit	ing. Loredana BEZNOȘKA	Data					Planșa Nr. 4
Desenat	ing. Loredana BEZNOȘKA						